



# NON-SLIP Hexagon Trim Tool

Create perfect pieced hexagons with 2", 4", or 6" finished centers by squaring up each round of strips as you go. Since each round is squared up before the next set is added, the blocks created are perfect hexagons. Or use the markings to cut 2", 4", 6" or 8" finished hexagons.

**Designed by Jean Ann Wright**

#CGRJAW4  
Made in USA



SEE A DEMO  
SCAN WITH ANY  
QR READER

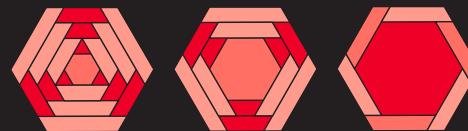

Creative Grids® USA, Inc  
400 W. Dussel Dr. Ste B  
Maumee, OH 43537  
www.creativegridsUSA.com

Creative Grids® UK, Ltd.  
Unit 23A Pate Road  
Leicester Road Industrial Estate  
Melton Mowbray  
Leicestershire, LE13 0RG  
England  
www.creativegrids.com



## NON-SLIP Hexagon Trim Tool

### Cutting Hexagons - 2", 4", 6", and 8"

Cut hexagon strips in the sizes indicated then position the Hexagon Trim Tool so the point of the tool is in the center of the strip. Cut up, then down to make the top of the fabric hexagon. Turn the cut strip and align the trim tool so the trimmed side is even with the markings on the tool for the size hexagon you are cutting. Cut up, then down again to finish cutting the hexagon.

1. Cut 2-1/2" wide pre-cut strips to yield 2" finished hexagons.

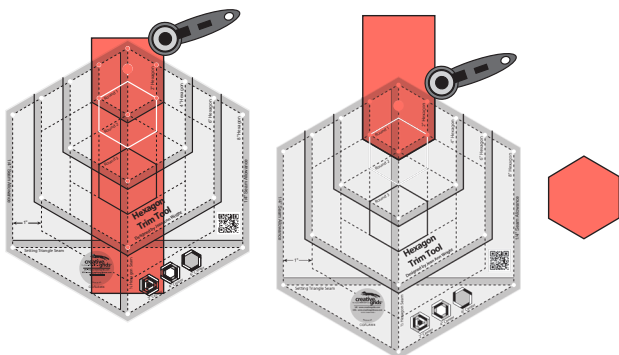

2. Cut 4-1/2" wide strips to yield 4" finished hexagons.

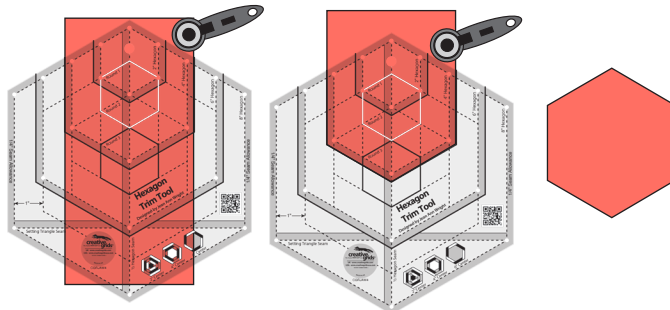

3. Cut 6 1/2" wide strips to yield 6" finished hexagons.

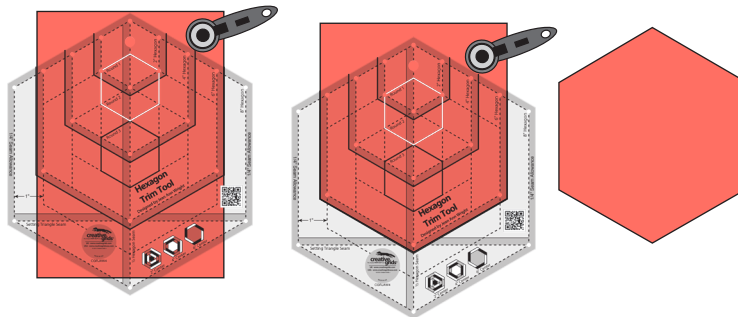

4. Cut 8-1/2 strips or use 10" pre-cut squares to cut 8-1/2" hexagons.

## NON-SLIP

# Hexagon Trim Tool (cont.)

(Figure A)

	Lights	Darks
<b>Round #1</b>	(3) 1-3/4" x 2"	(3) 1-3/4" x 4-1/2"
<b>Round #2</b>	(3) 1-3/4" x 3"	(3) 1-3/4" x 5-1/2"
<b>Round #3</b>	(3) 1-3/4" x 4"	(3) 1-3/4" x 7"

## 2" Hexagon Centers With Alternating Strips

**Center Hexagons:** Cut strips 2-1/2". Cut as instructed under "Cutting Hexagons".

**Round #1:** Center and sew the three 2" light strips to every other side of a 2-1/2" hexagon. Press away from the center. Center and sew the three 4-1/2" dark strips to the remaining three sides. Press away from the center. Using the Hexagon Trim Tool, position the solid white hexagon lines marked "Round 1" over the center hexagon and trim two sides. Repeat for the other four sides.

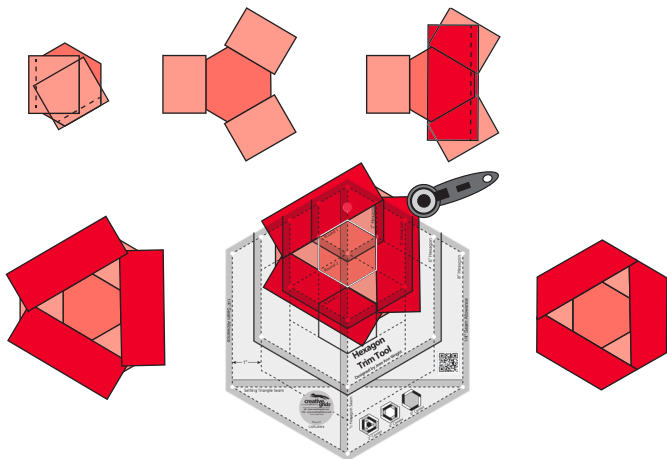

**Round #2:** Center and sew the three 3" light strips to the trimmed hexagon on the same three sides as in round #1. Press away from the center. Center and sew the three 5-1/2" dark strips to the remaining three sides. Press strips away from center. Using the Hexagon Trim Tool, position the dashed black hexagon marked "Round 2" over the center hexagon and trim two sides. Repeat on the remaining four sides.

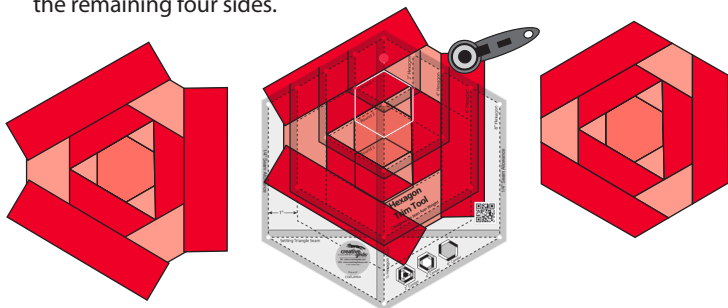

**Round #3:** Center and sew the three 4" light strips to the trimmed hexagon on the same three sides as in previous rounds. Press away from the center. Center and sew the 7" dark strips to the remaining three sides. Press away from the center. Using the Hexagon Trim Tool, position the solid black hexagon marked "Round 3" over the center hexagon and trim all six sides. Rotating the block and trim tool as necessary for safe cutting.

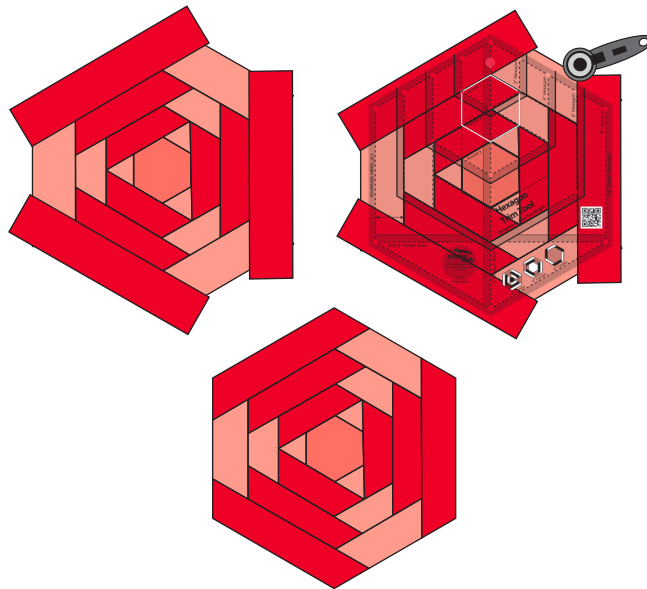

## 4" Hexagon Centers With Alternating Strips

**Center Hexagons:** Cut strips 4-1/2". Cut as instructed under "Cutting Hexagons".

**Cutting Alternating Strips:** Follow cutting chart Figure A) for rounds 2 & 3.

### Sewing:

1. Start with a 4-1/2" hexagon. Center and sew the 3" light strips from Round #2 (Figure A) to every other side of the hexagon. Press away from center. Next, center and sew the 5-1/2" dark strips from Round #2 (Figure A) to the remaining three sides. Press away from center. Using the Hexagon Trim Tool, position the point of the white solid "Round 1" centering hexagon on the seam line of the 4" hexagon. Dashed markings for the 4" hexagon will line up on the seam lines. Trim two sides. Repeat for the remaining four sides.

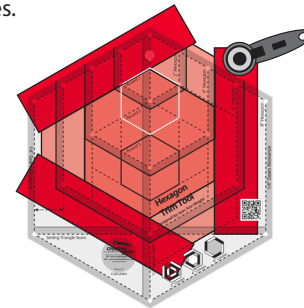

2. Center and sew the 4" light strips from Round #3 (Figure A) to the same three sides as in step 1. Press away from the center. Center and sew the 7" dark strips from Round #3 (Figure A) to the remaining three sides. Press away from the center. Using the Hexagon Trim Tool, position the point of the dashed black "Round 2" centering hexagon on the seam line of the 4" hexagon center. Trim all six sides, rotating block and ruler as needed for safe cutting.

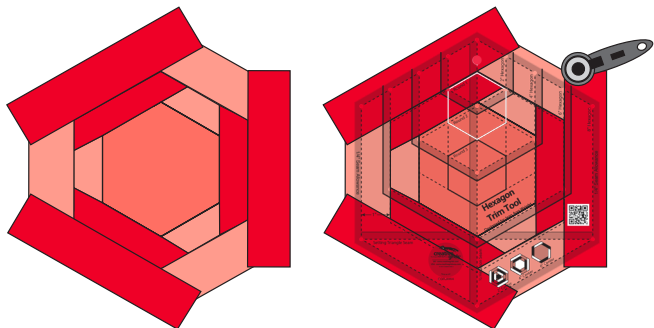

## 6" Hexagon Center With Alternating Strips

**Center Hexagons:** Cut strips 6-1/2". Trim as instructed under "Cutting Hexagons".

**Cutting Strips:** Cut three light and three dark strips 1-3/4" x 6".

### Sewing:

1. Partially sew one dark strip to one side of the hexagon starting in the middle of the side as shown. Press sewn section away from hexagon.

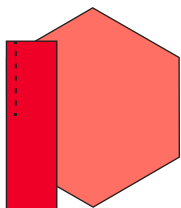

2. Work in a clock-wise direction, adding a light strip next. Stitching full edge of hexagon. Press away from hexagon. Continue adding strips, alternating dark and light.

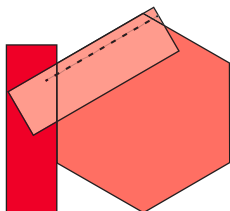

3. On the final light strip, be sure to fold first dark strip away before sewing 6th strip in place. Press 6th strip away from hexagon.

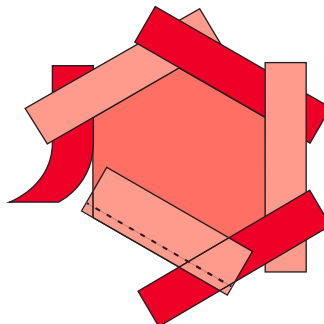

4. Finish sewing 1st strip in place. Press away from center hexagon.

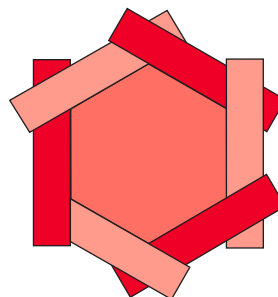

5. Using the Hexagon Trim Tool, position the point of the white "Round 1" center hexagon on the seam line of the 6" hexagon center. Dashed lines will line up on edges of 6" hexagon. Trim all six sides, turning block and trim tool as needed for safe cutting.

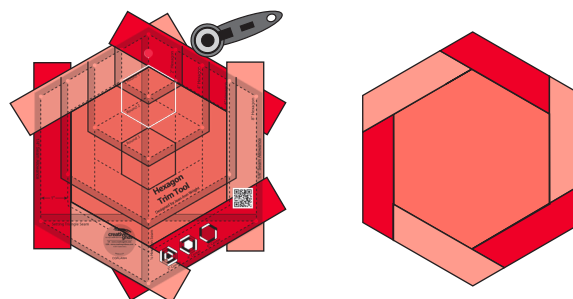

## Cutting Half Hexagons and Skinny Triangles

**Half Hexagons:** Cut fabric strips 4-1/2" x width of fabric. Position the Hexagon Trim Tool on the half hexagon line and cut the 30° angle on two sides to cut half hexagon setting pieces to square off the sides of the quilt. **Use holes to mark 1/4" intersections.**

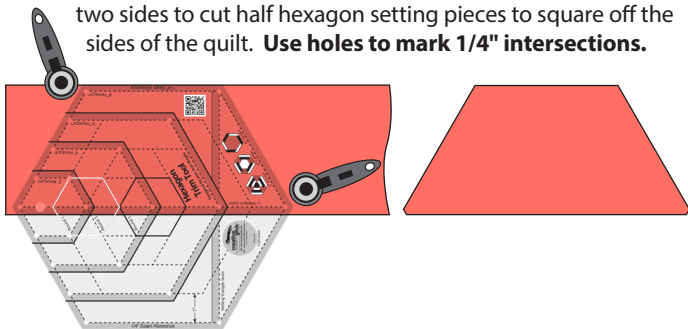

**Sewing the Half Hexagon:** Stitch the straight side of the half hexagon along the straight side of the center inset hexagon block. Start and stop stitching at the marked intersection points. Stitch up one side from the straight seam at an angle to the outside edge of the half hexagon. Repeat on the other side to set in the half hexagon that squares on the sides of the quilt project. Continue adding as needed.

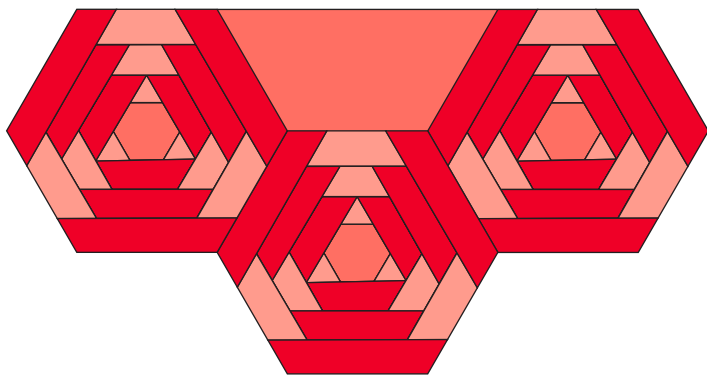

**Cutting Skinny Triangles:** Cut fabric strips 2-7/8" x width of fabric. Position the Hexagon Trim Tool on the skinny triangle line and cut the 30° angle on two sides to cut setting half triangles to square off the top and bottom of the quilt.

**Use holes to mark 1/4" intersections.**

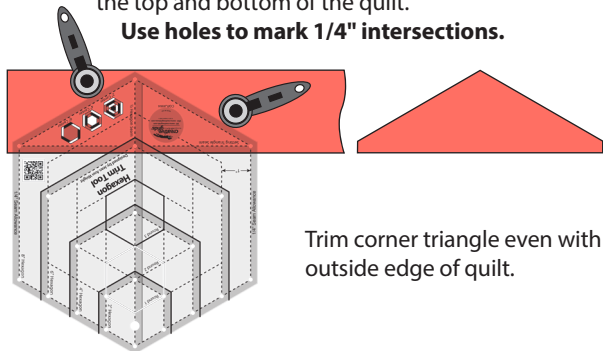

Trim corner triangle even with outside edge of quilt.

**Sewing the Skinny Triangles:** Stitch the short, straight side of the skinny triangle starting at the center point of the triangle and the intersection of the two hexagons that have been joined together. Fold out, press and repeat on the remaining short side of the adjacent hexagon. Skinny triangles square off the top of the quilt.

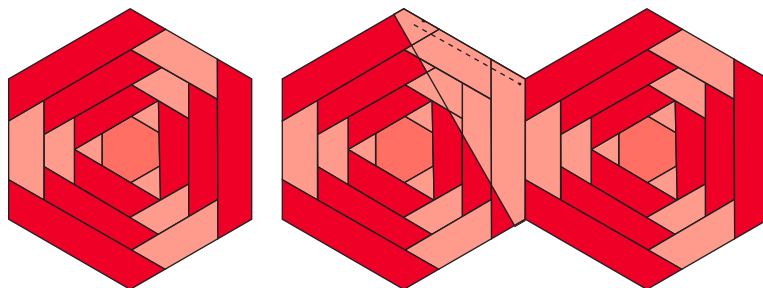

Trim corner triangle even with outside edge of quilt.

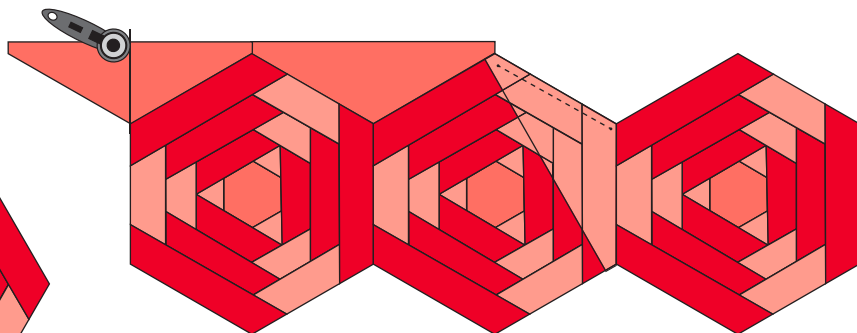

## Fussy Cutting Hexagons

Center a design in the desired size of hexagon and mark the finished size through the holes. Cut the fabric 1/4" away from the holes on opposite straight sides. Trim the angles sides.

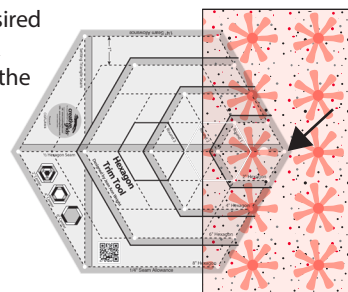

  
**creative grids®**  
The Original **NON-SLIP** Ruler